

## 规格承认书

—

\_\_\_\_\_

\_\_\_\_\_



prepare	
check	
approve	



TRX电容一级代理商  
深圳市弗瑞鑫电子有限公司

Add: 深圳市宝安区西乡大道302号金源商务大厦B座3楼  
Tel: 0755-29563634  
Fax: 0755-27447020



	- 2 2 . .		
	/		/
	/		/

	- 2 2 . .		
	/		/
	/		/

1. /

$\overline{\text{①}}$   $\overline{\text{②}}$   $\overline{\text{③}}$   $\overline{\text{④}}$   $\overline{\text{⑤}}$   $\overline{\text{⑥}}$

①

	- 2 2 . .		
	/		/
	/		/

3. /



4. /

5. /

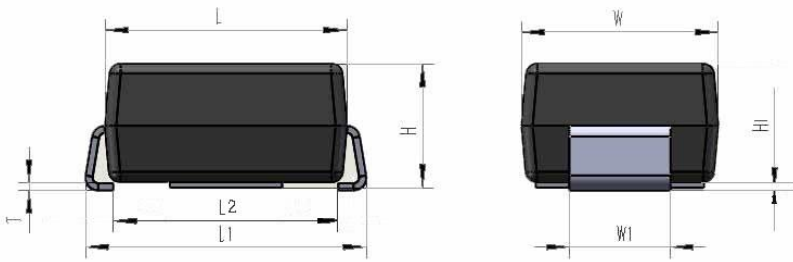

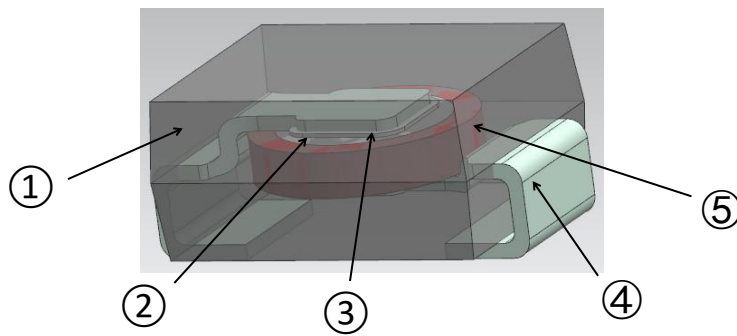
①		
②		
③		
④		
⑤		

- 2  
2 ..

/

/

/

	- 2 2 . .		
	/		/
	/		/

/

°  
°C

°

°

°

/

7. /



	- 2 2 . .		
	/		/
	/		/





- 2  
2 . .

/

/

/

/

					±
		±			
		±			
		±			
		±			





			± ±
			± ± ±
			± ± ±

8. /

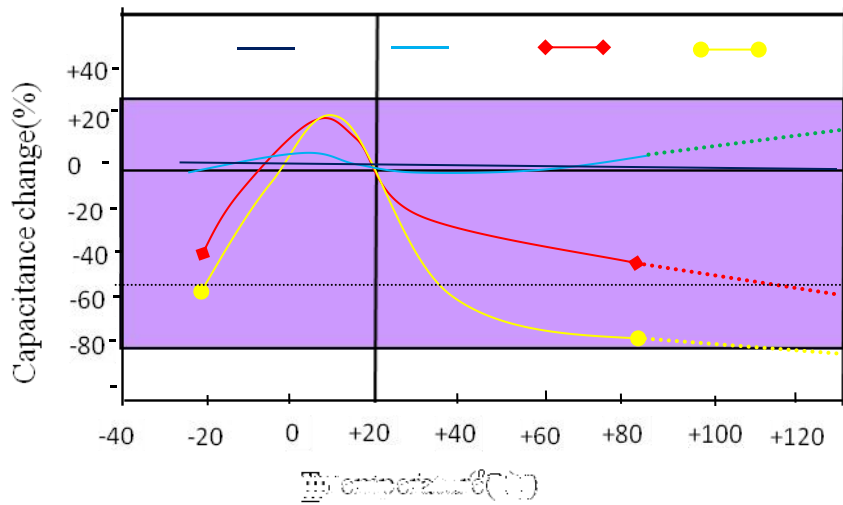

 <b>TRX</b> 专注电容器廿年	- 2		
	2 . .		
	/		/
	/		/

9.

/







10. /

(1)

(2)

/

/

(3)

(4)

×

11. /  
/

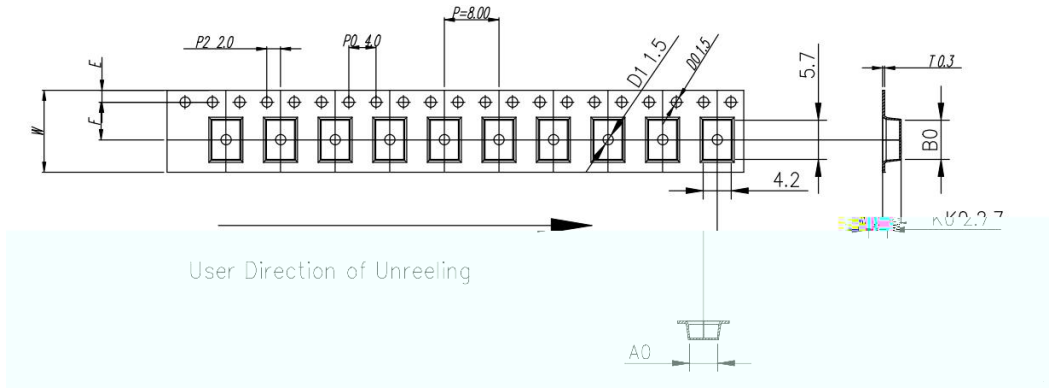



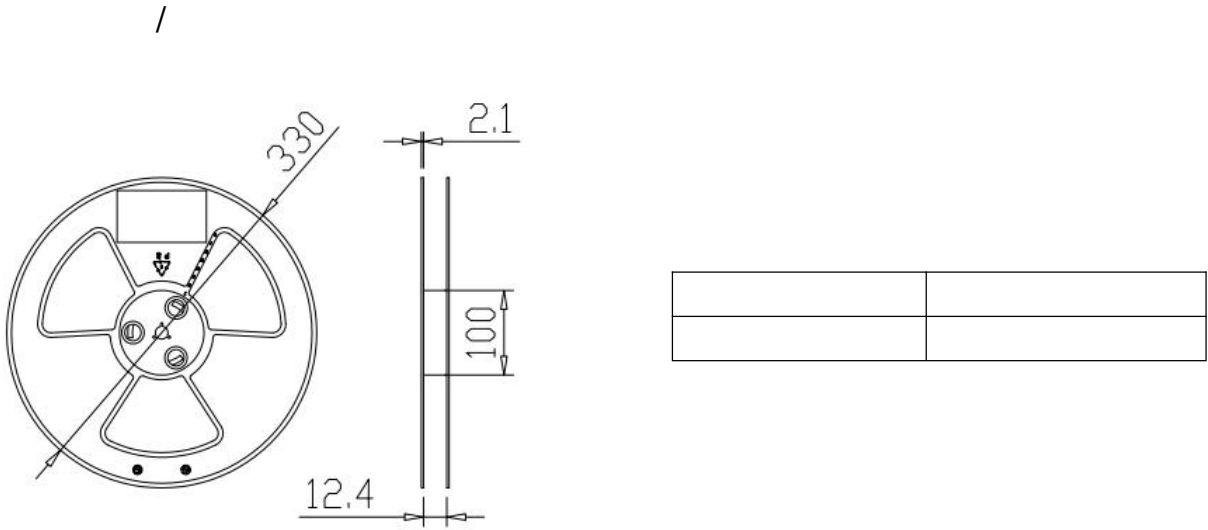

ITEM	W	A0	B0	K1	K0	P	F	E	D0	D1	P0	P2	T
DIM	12.0	$4.30^{+0.30}_{-0.30}$	$5.70^{+0.10}_{-0.10}$	--	$2.70^{+0.10}_{-0.10}$	8.00	$5.50^{+0.10}_{-0.10}$	1.75	$\phi 1.5^{+0.10}_{-0.10}$	$\phi 1.5^{+0.10}_{-0.10}$	4.0	2.0	0.30
ALTERNATE													



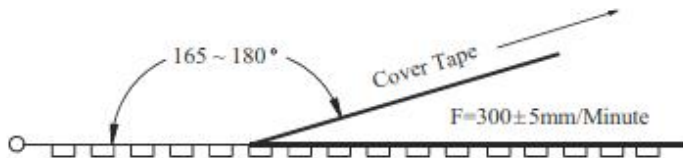

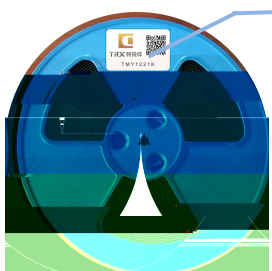
/

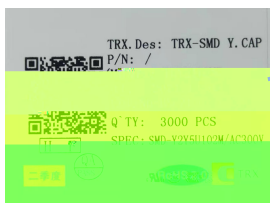
Item	Data	Remark
Cover tape adhesion	10 ~ 100g	Carrier tape and cover tape open angle 165 ~ 180° F=300±5mm/minute

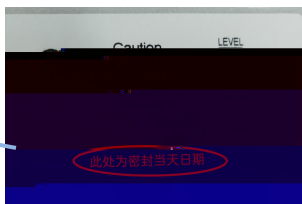

/ -			
 <p>标签</p>	 <p>料号</p>		
		 <p>此处为密封当日日期</p>	

/ -			
			
图示 /	图示 /	图示 /	

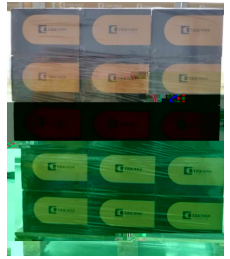
/ :			
			
/	/		

" "



	- 2 2 . .		
	/		/
	/		/

12. /

①

②